

POWERNAIL® CO.

Powernail 50P Pneumatic Powernailer®



OPERATION AND MAINTENANCE MANUAL MANUAL DE OPERACION Y DE MANTENIMIENTO MANUEL D'INSTRUCTIONS ET D'ENTRETIEN

WARNING



Read this manual before you use this Powernailer®. Follow all safety warnings and instructions. If you are uncertain about the operation of the nailer, call us directly at 1-800-323-1653 for assistance or contact the closest Powernail Dealer for help. Please retain this information for future reference.

INTRODUCTION

The Model 50P is designed to bring Powernail® quality to a Pneumatic Nailer suitable for use on thinner 3/8", 1/2", 5/8" and 3/4" solid tongue and groove hardwood.

The Model 50P with 18 gage Powercleats is your best choice for the denser hardwoods available in today's market place such as 3/4" exotic flooring including Brazilian Cherry and Bamboo. The use of 18 gauge Powercleats® provides a strong and durable Powercleat® necessary to penetrate these density's and provide an excellent bond to the underlayment.

The Model 50P is designed to use cleat lengths of 1", 1-1/4", 1-1/2", and 1-3/4".

The Powernail FLEX is recommended for use on thinner 3/8", 1/2", 5/8" and 3/4" solid tongue and groove hardwood as well as some other hard exotics, bamboo, and engineered woods.

For a superior pneumatic Nailer, look to the company that has been the industry's quality leader, **POWERNAIL® COMPANY, INC.**

INDEX

Index.....	2	Parts List.....	9-11
Warranty.....	2	Seal Locations Diagram.....	12
Safety Instructions.....	3	Schematic	13
Powernail Company Info.....	3	Depth Chart.....	14
Operating Instructions.....	4-8	Troubleshooting Chart.....	15
Parts & Service.....	5-8		
Drive Blade.....	6		
Seal Replacement.....	6-7		
Safety Labels.....	8		

LIMITED WARRANTY

POWERNAIL® Company, Inc. warrants to its customer, and to the first end-use purchaser of POWERNAIL flooring nailers purchased from an authorized POWERNAIL distributor, that each serialized manufactured nailer by POWERNAIL®, for a period of 12 months from the date of purchase, and with respect to the nailer body (specifically Models 200, 445, and 50P), for a period of 10 years from date of purchase, ("warranty period"); shall be free of defects in materials and workmanship and will meet POWERNAIL's specifications in effect at the time of Product shipment. POWERNAIL will repair or replace, at its option, any Powernailer® that does not conform to this warranty. Claims must be made no later than fifteen (15) days after the end of the warranty period. POWERNAIL will perform all repair or replacements itself or through its authorized contractors. POWERNAIL is not responsible for shipping, labor or other direct or indirect costs. Damage caused by abuse, misuse, unusual or excessive wear is excluded. Repair or modification of the Products by unauthorized parties will void this warranty. The customer is responsible for returning Products to POWERNAIL for verification of nonconformance. Warranties for Products not manufactured by POWERNAIL are limited to warranties provided to POWERNAIL by the manufacturer of such product that are assignable to customer.

THESE WARRANTIES AND REMEDIES ARE EXCLUSIVE OF ALL OTHERS, EXPRESS OR IMPLIED. THE WARRANTIES OF MERCHANTABILITY AND FITNESS FOR PURPOSE ARE EXPRESSLY EXCLUDED. IN NO EVENT SHALL POWERNAIL'S LIABILITY FOR A WARRANTY CLAIM EXCEED THE PRICE PAID TO POWERNAIL FOR THE NONCONFORMING PRODUCT, REGARDLESS OF THE FORM OR BASIS OF THE CLAIM OR CAUSE OF ACTION.

SAFETY INSTRUCTIONS



Always use approved **SAFETY GLASSES** and **EAR PROTECTION** when operating this Nailer. The operator and others in the work area should always wear approved **FRONT** and **SIDE** eye protection when operating this Nailer. Eye protection will help guard against flying nails and debris, which could cause severe eye injury.



EYE AND EAR PROTECTION should be used to prevent hearing damage when there are high noise levels in the work area.

ALWAYS use ear plugs with a noise reduction rated at 29 db or higher at a construction site.

Nailer noise ratings are at LPA-1sd=90.6,
LWA-1sd=99.3 and LPA-1s,1m=86.3.
Nailer vibration rating: $m/s^2=3.05$.

Always **DISCONNECT THE AIR SUPPLY** before making any adjustments, repairing, clearing jams or when the Nailer is not in use. Do not use on scaffolding or ladders and disconnect nailer from air supply when transporting between installation areas.

Never attach the female end of a quick disconnect to the Nailer. This will trap air inside the Nailer and permit it to be discharged. Only the unrestricted male connection should be attached to the Nailer.

Nailer requires an air source that can continuously deliver 80 to 110 psi at 3-1/2 cubic feet of air per minute for operation.

Normal air pressure should not exceed 120 psi or damage to the Nailer and seals may occur. Excess air pressure can cause the Nailer to explode.

To prevent fire or explosion, use only regulated compressed air—do not use bottled gases of any kind (no oxygen or combustible gasses) to power this Nailer.

Nailer is intended for use installing wood flooring and is not to be used for purposes not specified in the operations manual.

The trigger is a safety device and should only be pulled when the Nailer is in proper Position on the work surface and before the plunger is struck with the mallet. Do not tie or tape down the safety trigger as the Nailer could discharge if dropped on the plunger. The Nailer will not fire unless the trigger is pulled before the mallet blow. Do not use the trigger safety as a lock up for the plunger then rack the wood using the locked up Nailer body. It will severely damage the Mechanism and the Nailer. Use the mallet to rack the wood strip, not the Nailer.

Do not use any nails other than Powernail Powercleats Nails which are specifically designed for use in any Powernailer. Powercleats Nails are available in various lengths. Contact your Powernail Dealer for Powercleats Nails.

Use only Powernail replacement parts in the repair or maintenance of this nailer. Parts or repair services are available from the manufacturer or from agents authorised by the manufacturer. Repairs should be carried out only by trained service personnel in the field of fastener driving tools who will observe proper safety controls while performing maintenance. Service personnel should be qualified to assess the safe working condition of fastener driving tools.



Never place any part of the body in the discharge path of the Nailer when air is connected to the Nailer. Always make sure Nailer is empty of cleats before connecting air hose so as to prevent any accidental discharge from occurring.

Never leave the Nailer unattended while it is connected to an air supply.

Whenever air is connected to the Nailer, keep body parts away from the nail discharge path. Disconnect the air line before making adjustments or repairs on the Nailer. Only connect air to an unloaded Nailer so as to prevent accidental discharge.

POWERNAIL COMPANY, INC.
1300 Rose Road, Lake Zurich, IL 60047 US
Phone: 1-800-323-1653 OR 847-847-3000
www.powernail.com

OPERATION

Read these instructions carefully before you use the Nailer.

To use the Model 50P, simply place the nailer on the floor, pull nailer back so locating ears catch the edge of the floor above the tongue, pull the safety trigger and tap the plunger with the rubber capped mallet end and let the Nailer drive and set the nail at the correct 45 degree angle.

Adjust nailer by adding shims between the adapter foot and pad until there is a slight gap between the tongue of the wood and the locating ears of the adapter foot. See example 1B and 2A.

WARNING: Do not use any nails other than Powernail Powercleats® (18 gage) nails, which are specifically designed for use in the Model 50P Powernailer.

Powercleats® (18 gage) nails are available in 1", 1-1/4", 1-1/2" or 1-3/4" lengths to accommodate 3/8", 1/2", 5/8" and some exotic 3/4" tongue and groove hardwood flooring. Contact your Powernailer® dealer for Powercleats® nails.

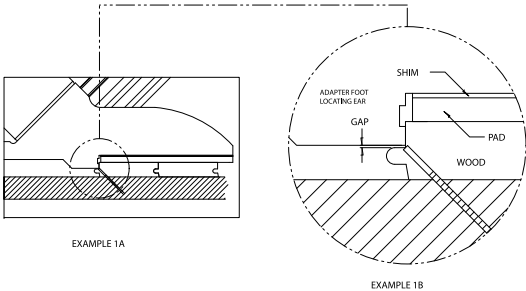

EXAMPLE 1A

EXAMPLE 1B

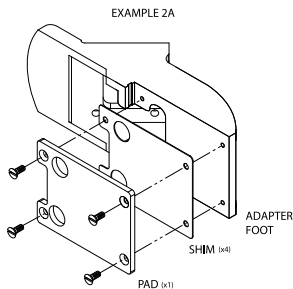

EXAMPLE 2A

To Load the Model 50P

Pull back the spring loaded nail pusher towards the end of the channel until the pusher plate locks (Figure 1). Place up to one stick (100) of Powercleats® (18-gauge) nails, 1", 1-1/4", 1-1/2" or 1-3/4" long into the nail feed slot located on the top of the channel (Figure 2). Release nail pusher from locked position and gently guide it down until it meets the end of the cleat strip (Figure 3).

To Unload the Model 50P

Pull back the spring loaded nail pusher towards the end of the channel until the pusher plate locks. Then turn the nailer over so that the nails slide out of the top nail feed

Figure 1.



Figure 2.

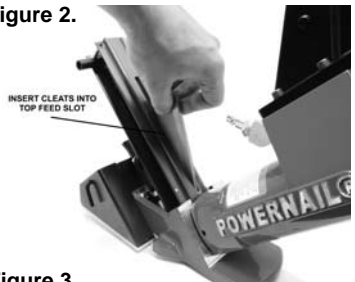

Figure 3.



OPERATION, continued...

WARNING: It is not necessary to hit the Nailer hard to activate it. Never hit the Nailer with excessive force or with the metal end of the mallet, this will damage the Nailer.

Never use the Safety Trigger interlock to lock up the plunger and rack the wood with blows to the Nailer body. This will severely damage the safety mechanism and Nailer. This abuse and damage is not covered by the warranty.

Before each use check all screws to be sure they are tight. Shock and vibration can loosen screws. Do not over tighten any screw.

AIR SUPPLY:

The air must be clean and dry. Dirty and/or wet air will damage the Nailer. A combination filter-regulator-lubricator is required for proper Nailer performance and should be placed close to the Nailer per manufacturer's recommendations.

The air source must continuously deliver 80 to 110 psi at 3-1/2 cubic feet of air per minute to operate the Nailer. Connect a clean air hose and air regulator to the Nailer.

Check for air supply leaks that waste air and starve the Nailer of air thereby reducing its performance.

LUBRICATION:

If you do not use an in line lubricator, you must lubricate the Nailer manually. The frequency of lubrication is dependent upon the duty cycle of the Nailer. Continuous duty requires more frequent oiling than intermittent duty.

At least every eight (8) hours place two to four drops of Mobile DTE Light Oil, supplied with your Nailer, into the disconnected air line male connector attached to the Nailer. **WARNING:** Detergent oil is not recommended and may damage the seals.

WARNING: Do not over lubricate the Nailer, excess oil mist or drops will be vented with spent air when over lubricated. Excess oil could stain the wood flooring, walls or furnishings. Dry fire the Nailer, without nails, to purge excess oil, before you begin to nail down flooring. **We will not be responsible for oil stains.** Before storing the Nailer, lubricate and cycle the Nailer in insure internal parts are oil protected from corrosion.

PARTS & SERVICE:

When ordering parts include the part number, part description, Powernailer model and serial number. Be sure to state the quantity of the part(s) required. Contact your Powernail Dealer for the necessary parts or service.

WARNING: Never work on the Nailer if the air line is attached. Always disconnect the air line from the Nailer first.

NAILER DISASSEMBLY:

TO REPLACE RUBBER BUMPER (#31):

1. Disconnect the air supply
2. Remove the four (4) cap screws holding the Adapter Foot, Foot and Nail Channel assembly to the main Body (see illustration).
3. Pull the Rubber Bumper out of the cylinder bore. Replace the old Bumper if it shows signs of wear or it is split.
4. Reverse these steps to reassemble the Nailer. Be sure to align the Driving Blade with the slot in the Nail Channel Assembly while you reassemble the Nailer. **NEVER FIRE THE NAILER WITHOUT THE RUBBER BUMPER INSTALLED, IT WILL DAMAGE THE NAILER.**

OPERATION, continued...

TO REPLACE DRIVING BLADE(#17):

1. Disconnect the air supply
2. Remove the four socket head cap screws holding the Adapter Foot, Foot and Nail Channel Assembly to the body.
3. Remove the Rubber Bumper
4. Pull the Driving Blade with pliers until the Piston is fully extended outward towards the bottom of the cylinder.
5. Use a 15/16" box wrench (Part #: 09-445-29768) to unscrew the Driving Blade Jam Nut and remove it. Hold the Piston from turning while unscrewing the Jam Nut by holding the piston hex with a 1-1/8" box wrench (Part #: 09-445-29768).
6. Push out the 1/4" diameter blade retaining Dowel Pin and remove the broken Driving Blade stub.
7. Install a new Driving Blade in the slot and replace the Dowel Pin. Screw on the retaining Jam Nut using the same tools. If the Jam Nut becomes worn and loose after frequent removals, it should be replaced.
8. Check the fit, there should be some sideways movement between the Driving Blade and the Jam Nut assembly. This is desirable and helps the blade to align itself with the mating parts.
9. Reassemble the components. Be sure to align the Driving Blade with the slot in the Adapter Foot Assembly, it goes in only one way.

DRIVING BLADE ASSEMBLY REMOVAL:

1. Disconnect the air supply.
2. Remove Rubber Plunger Cap (#18).
3. Unscrew & remove Body Cap (#2).
4. Push Safety Yoke (#26) aside and unscrew the three 10-32 cap screws holding the Plunger (#13) to the Return Cylinder (#12).
5. Pull the Plunger up and out of the Nailer Body (#1) cavity.
6. Remove the Return Cylinder O Ring Gasket (#34) located on the top of the Return Cylinder under the Plunger.

7. Turn the Nailer over and remove the four cap screws (#48), that fasten the Adapter Foot and Nail Channel Assembly to the Nailer Body and lift the Assembly off the Body.
8. Remove the Rubber Bumper (#31).
9. Pull the Driving Blade Assembly out of the Nailer Body by pulling on the Driving Blade.
10. Hold the Piston Rod (#10) with an 11/16" socket over its hex end opposite the Piston. **Do not use pliers or a vise anywhere on the metal parts, they can damage the sealing surfaces.**
11. Use box wrenches to remove the 5/8-18 Jam Nut (#49). Remove the Dowel Pin (#42) and Driving Blade (#17).
12. Unscrew the Piston from the Piston Rod using box wrenches and separate the Piston, Piston Rod and Return Cylinder.

SEAL REPLACEMENT:

There are 7 seals that may require replacement. We recommend that you have your POWERNAIL Dealer replace the Seals.

SEAL KIT:

You may choose to buy a Seal Replacement Kit and replace the seals yourself. It is good practice to replace all seals at one time regardless if only one seal needs replacement.

SEAL DESCRIPTION & NUMBER:

1. Piston U cup Lip Seal (#19)
2. Return Cylinder U cup Lip Seal (#20)
3. Piston Rod U cup Lip Seal (#21)
4. Rubber Seat (#30)
5. Plunger Seal Set (#32)
6. Plunger Wiper Seal (#33)
7. Return Cylinder O Ring Gasket (#34)

To change Seals follow these procedures. Be sure the air line is disconnected from the Nailer first before making any repairs. Consult the illustration for the name and location of the following component parts.

OPERATION, continued...

TO REPLACE THE SEALS:

Plunger Seal Set (#32):

1. Remove the Teflon[®] Seal and its O-ring expander from the Plunger groove using a bent paper clip or pick. Be sure not to scratch the inside walls of the seal groove with the wire hook.

2. Clean out the seal groove. Place a new O-ring into the seal groove by stretching it over the Plunger body. Make sure the O-ring is not twisted in the groove. Place a new Teflon[®] Seal Ring into the seal groove over the O-ring.

3. Carefully push the Teflon[®] Seal Ring over the edge of the Plunger with your thumbs and into the groove. Do this as quickly as possible to reduce stretching of the Teflon[®] Seal Ring. **DO NOT OVER STRETCH THE TEFLON[®] SEAL RING.** Be sure the Teflon[®] Seal Ring is centered all around the seal groove and not twisted.

4. Wipe off the Seal surface with a clean rag and lubricate it generously with the supplied Mobile DTE Light air tool oil lubricant.

Rubber Seat (#30):

1. Remove the Cylinder Sleeve (#14). The Cylinder Sleeve would slide out of the Nailer Body when you pull out the Driving Blade

2. Remove the metal Support Ring (#29) and Rubber Seat from inside the Nailer body. **NOTE THAT THE CHAMFER ON THE INSIDE OF THE RUBBER SEAT FACES THE BOTTOM OF THE NAILER.** Do not reverse the direction of the chamfer when you replace the Rubber Seat.

3. Replace the Rubber Seat, Support Ring and Cylinder Sleeve. Be sure to re install the steel Cylinder Sleeve with the chamfered inside edge facing the **BOTTOM** of the Nailer.

Piston U Cup Lip Seal (#19):

1. Remove the old Piston U Cup Lip Seal from the Piston using a bent paper clip or pick, being careful not to scratch the inside walls of the seal groove or the edge of the Piston with the wire hook.

2. Clean out the seal groove. Place a new U-Cup Lip Seal into the groove. Make sure the lip seal is not twisted in the groove and the lips face the top of the Nailer. See the sketch on next page (#19).

3. Carefully wipe off the U Cup Lip Seal surface with a clean rag and lubricate it generously with the supplied Mobile DTE Light air tool oil lubricant.

Return Cylinder U Cup Lip Seal (#20):

1. Use a bent paper clip or pick to remove the old U Cup Lip Seal from the internal seal groove inside the Return Cylinder. Be careful not to scratch the inside walls of the seal groove with the wire hook.

2. Clean out the seal groove. Place a new U Cup Lip Seal into the groove, be sure it is not twisted in the groove. Be sure the lips are facing the inside of the Return Cylinder as shown on the Seal Placement sketch on page 10.

WARNING: The U-Cup Lip Seals #20 and #21 look alike, but they are different, **DO NOT** mix them up.

3. Carefully wipe off the Lip Seal surface with a clean rag and lubricate it generously with the supplied Mobile DTE Light air tool oil lubricant.

Piston Rod U-Cup Lip Seal (#21):

1. Remove the old U-Cup Lip Seal from the seal groove with a bent paper clip or pick using care not to scratch the inside walls of the seal groove with the wire hook.

2. Clean out the seal groove and install a new U-Cup Lip Seal. Be sure the Lips are facing the right direction and are not twisted in the groove. See the sketch on next page.

Plunger Wiper Metal Cap O-Ring (#33):

1. Use a bent paper clip to pick out the felt Wiper Seal out of its groove in the Body Cap (#2).

2. Clean out the groove and insert a new felt Wiper Seal. Saturate the new felt Wiper Seal with oil.

OPERATION, continued...

Return Cylinder O-Ring Gasket (#34):

1. Place a new O-Ring Gasket in the groove on top of the Return Cylinder when you reassemble the Driving Blade Assembly.
2. Wipe off the O-Ring Gasket seal surface and lubricate it generously with the supplied lubricant, Mobile DTE Light air tool oil lubricant.

REASSEMBLING THE NAILER:

1. Be sure the Rubber Seat, Support Ring and Cylinder are installed in the Body and are facing the correct direction.

2. All seal surfaces must be clean and lubricated generously with the supplied Mobile DTE Light air tool oil lubricant.

Replace any part that shows signs of wear.

3. Use care when installing the seals into their respective cavities. Be sure the Seals are contained in their groove and do not come out as the parts slide together. Generous cavity lead in chamfers have been provided to help Seal installation.

4. Carefully insert the Piston Rod into the Return Cylinder and screw the Piston onto the rod. Be sure the Piston is facing the correct way, ears up, hex down.

5. Assemble the Driving Blade, Dowel Pin and Jam Nut on to the Piston Rod.

6. Insert the Driving Blade Assembly up into the bottom of the Nailer Body Cylinder.

7. Be sure there is a new O-Ring Gasket in the top groove of the Return Cylinder.

8. Insert the Plunger into the top cavity of the Body. Line up the holes and install the three Plunger retaining screws. It is important that the three #10-32 screws are tight or air leakage will occur. Our recommendation is to use 1-2 drops of blue Loctite® or similar on the 3 screws.

For Step-by-Step Videos and Instructions, Visit our Web Site at: www.Powernail.com

9. Install the Body Plate.

10. Position the Safety Yoke into the Plunger Groove.

11. Install the Body Cap and Plunger Rubber Cap.

12. Turn the Nailer upside down. Install the Rubber Bumper, Nail Channel Assembly and Adapter Foot. Be sure to align up the Driving Blade with the slot in the Foot before the Nailer is closed up.

13. NEVER FIRE THE NAILER WITHOUT THE RUBBER BUMPER INSTALLED, IT WILL DAMAGE THE NAILER BEYOND REPAIR.

TO CLEAR A NAIL JAM:

Simply remove the two 1/4 - 28 x 1/2" screws (Item #66) with a 3/16" Allen wrench.

Slide the Gate Plate (Item #16) down and lift out.

You can now clear and inspect the Drive Blade path.

To re-assemble: Replace the Gate Plate (Item #16) and two screws (Item #66) and tighten firmly.

NAILER SAFETY DECALS

Warning!



- Read and understand the tool labels and manuals before operating. • Operators and others in work area MUST wear EYE and EAR protection. • Use safety glasses with side shields. • NEVER point tool at yourself or others in the work area. • Only connect air to an unloaded tool and always keep tool pointed in a safe direction. • Disconnect air when clearing jams, servicing or when tool is not in use. • Use only clean, dry, regulated air not exceed 110 psi. • Never use oxygen or other bottled gasses-explosion may occur. • Do not tie down, alter or remove the Safety Trigger.

CAUTION

1. Do not tie down the Safety Trigger
2. To prevent accidental discharge never attach air hose to loaded Nailer.

CAUTION:

Lubricate Nailer with 2-4 drops of Industrial Light Oil for every 8 hours of use.

POWERNAIL 50P REAR LOAD CHANNEL AND ORIGINAL FOOT PARTS LIST

If your nailer was manufactured in or before 2017, you may have the rear load channel configuration and/or original foot, gate, and gate plate. These parts have since been revised but are still available as replacement parts. Please check your nailer to determine it's configuration before ordering parts.

Item #	PART NO.	DESCRIPTION	Qty Req'd	Tuneup Kit	Sold Separate or Assembly #
8	09-50P3006	Foot (Original)	1		S
9	09-50P3008	Channel (Rear Load)	1		S
15	09-50P3042	Gate (Original)	1		S
16	09-50P3017	Gate Plate (Original)	1		S
22	09-2003034	Nail Pusher Spring (Rear Load)	1		S
23	09-2003035	Spool	2		S
39	09-44529735	Nail Pusher (Rear Load)	1		S
43	09-44529741	Roll Pin (Original)	1		S
47	09-44529745	#10-32 X 1-1/4 SHCS (Knob) (Rear Load)	1		S
52	09-44529754	#10-32 X 1/2 SHCS (Foot) (Original)	1		S
57	09-44529822	#10-32 X 3/4 SHCS w/patch (Gate) (Original)	1		S
60	09-50P3040	Channel Plate (Rear Load)	1		S

Powernail FLEX Assemblies, Kits

ITEM	PART NO.	DESCRIPTION	QTY
A-9	09-2003063A	Nail Pusher Assembly (Rear Load)	1

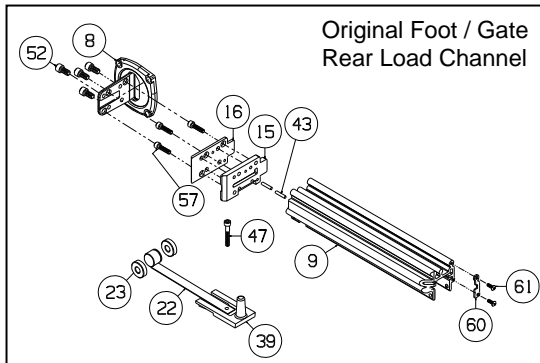

50P PARTS LIST

**For this parts list and other Powernailer schematics, please visit the
Powernail Parts Store at <http://www.powernail.com>**

Item #	PART NO.	DESCRIPTION	Qty Req'd	Tune-up Kit	Seal Kit	Sold Separate or Assembly/Kit #
1	09-50P3001	Body	1			F
2	09-50P3002	Cap	1			S
4	09-44529703	Handle - Long	1			S, A-2
6	09-44529704	Handle Half Cover	1			S, A-2
7	09-50P3005	Adapter Foot	1			S
8R2	09-50P3006R2	Foot (Revision 2)	1			S, A-14, A-16, A-20
9TL	09-50P3056	Channel (Top Load)	1			S, A-15, A-16, A-20
10	09-50P3010	Piston Rod	1			S, A-6
11	09-200-3011	Piston	1			S, A-6
12	09-200-3013	Return Cylinder	1			S, A-6
13	09-2003014	Plunger	1			S, A-6
14	09-2003015	Cylinder Sleeve	1			S
15R2	09-50P3042R2	Gate (Revision 2)	1	TU		S, A-14, A-16, A-20
16R2	09-50P3017R2	Gate Plate (Revision 2)	1	TU		S, A-14, A-16, A-20
17	09-50P3018	Driving Blade	1	TU		S, A-6
18	09-2003022	Rubber Cap	1	TU		S
19	09-2003026	Piston U-cup Lip Seal	1	TU	SEAL	S, A-1, A-6
20	09-2003027	Return Cylinder U-cup Lip Seal	1	TU	SEAL	S, A-1, A-6
21	09-2003028	Piston Rod U-cup Lip Seal	1	TU	SEAL	S, A-1, A-6
22TL	09-50P3055	Nail Pusher Spring (Top Load)	1			S, A-15, A-16, A-20
23TL	09-445297341	Spool	2			S, A-15, A-16, A-20
24	09-44529832	#10-32 X 3/4 SHCS w/patch (Plunger)	3			S, A-6
25	09-2003057	#10-32 X 1/2 FHCS Slotted (Pad)	4			S
26	09-44529707	Safety Yoke	1			S
27	09-2003019	Body Plate (.035 Thick)	1			S
28	09-44529720	Trigger	1			S/A-2
29	09-44529721	Support Ring	1			S
30	09-44529723	Rubber Seat	1	TU	SEAL	S, A-1, A-6
31	09-44529724	Rubber Bumper	1	TU		S, A-6
32	09-44529725	Plunger Seal Set	1	TU	SEAL	S, A-1, A-6
33	09-44529729	Plunger Wiper Metal Cap O-Ring	1	TU	SEAL	S, A-1
34	09-44529731	Return Cylinder O-ring Gasket	1	TU	SEAL	S, A-1, A-6
36	09-44529732	Trigger Cable - Long	1			S, A-2

KEY: S=Sold Separately, A= Sold as part of assembly, F=Factory replacement only, K=Sold as part of a Kit

(Model 50P Parts List, continued)

Item #	PART NO.	DESCRIPTION	Qty Req'd	Tune-up Kit	Separate or Assembly/Kit #
38	09-44529733	Safety Yoke Springs	2		S
39TL	09-50P3050	Nail Pusher (Top Load)	1		S, A-15, A-16, A-20
40	09-44529735.2	Nail Pusher Knob	1		S, A-15, A-16, A-20
41	09-44529739	1/4 X 3/4 Dowel Pin (Trigger)	1		S, A-2
42	09-44529740	1/4 X 1/2 Dowel Pin (Driving Blade)	1	TU	S, A-6
45	09-44529743	1/4-20 X 1 SHCS (Cap)	4		S
46	09-44529744	1/4-20 X 3/4 SHCS w/patch (Handle Base)	4		S
48	09-44529747	1/4-20 X 1-1/4 SHCS w/patch (Foot)	4		S
49	09-44529748	5/8-18 Jam Nut (Driving Blade)	1	TU	S, A-6
50	09-44529750	#8-32 X 1-1/2 FHCS (Spacer)	2		S, A-16, A-20
51	09-44529751	#8-32 Locknut (Spacer)	2		S, A-16, A-20
53	09-44529756	1/4 X 1 Spacer (Channel)	2		S, A-16, A-20
54	09-44529758	1/4 Split Ring Lock Washer (Foot)	4		S
55	09-44529759	3/8 NPT 45 Degree Street Elbow	1		S
56	09-44529760	#8-32 X 1/4 BHCS (Cable)	1		S
58	09-50P3037	.200 Thick UHMW Plastic Pad	1		S
59	09-50P3038	Shim	4		S
62	09-50P3036	.150 Thick Plastic Pad	1		S
63	09-445297441	1/4-20 X 3/4 SHCS (Handle Half)	2		S, A-2
64	09-50P3045	#10-32 x 3/4" FHCS w/patch (R2 Gate)	3	TU	S, A-14, A-16, A-20
65	09-50P3046	1/4-20 x 5/8" SHCS w/patch Torx Drive T27 (R2 Foot)	2		S, A-14, A-16, A-20
66	09-50P3047	1/4-28 x 1/2" SHCS w/patch (R2 Gate Plate)	2	TU	S, A-14, A-16, A-20
100	09-4455418	1/4" Air Fitting 3/8" NPT	1		S
101	09-50P3052	Bushing (Top Load)	1		S, A-15, A-16, A-20
102	09-50P3053	#8-32 x 3/8"L FHCS w/patch (Top Load)	1		S, A-15, A-16, A-20
103	09-50P3054	Pusher Plate (Top Load)	1		S, A-15, A-16, A-20

KEY: S=Sold Separately, A= Sold as part of assembly, F=Factory replacement only, TU=Tune-up Kit

Model 50P Assemblies, Kits and Accessories

ITEM	PART NO.	DESCRIPTION	QTY	KEY
A-1	09-2003058A	Seal Kit (1 Each Of All Seals)	1	S
A-2	09-44529759A	Long Handle Assembly	1	S
A-6	09-50P3064A	Driving Blade Assembly	1	S
A-7	09-AW445	Allen Wrench Set	1	S
A-8	09-44529757A	6 Oz. Bottle Mobile Dte Light Oil	1	S
A-12	09-44529768	Box Wrench (2)	2	S
TU	09-50PTUKITR2	Tune-up Kit for all (R2) 50P, 50P FLEX, & 50P Power Rollers		
A-14	09-50PFOOTKIT	Foot assembly, includes R2 Foot, Gate, Gate Plate, and Screws.	1	S
A-15	09-50P3050A	Nail Pusher Assembly (Top Load)	1	S
A-16	09-50P3056A	Nail Channel Assembly (Top Load)	1	S
A-20	09-50P3061A	Long Nail Channel Assembly (Top Load)	1	S

SEAL PLACEMENT

SEAL P/N & LOCATION

#33
PLUNGER WIPER SEAL
#09-445-29729

#21
PISTON ROD U-CUP SEAL
#09-200-3028
INSTALL AS SHOWN

#20
RETURN CYLINDER U-CUP SEAL
#09-200-3027
INSTALL AS SHOWN

#19
PISTON U-CUP SEAL
#09-200-3026
INSTALL AS SHOWN

#34
RETURN CYLINDER
O-RING GASKET
#09-445-29731

#32
PLUNGER SEAL
#09-445-29725

#30
RUBBER SEAT
#09-445-29723
INSTALL AS SHOWN

DRIVING
BLADE

MODEL 50P SCHEMATIC

**For this and other Powernailer schematics, please visit the
Powernail Parts Store at <http://www.powernail.com>**

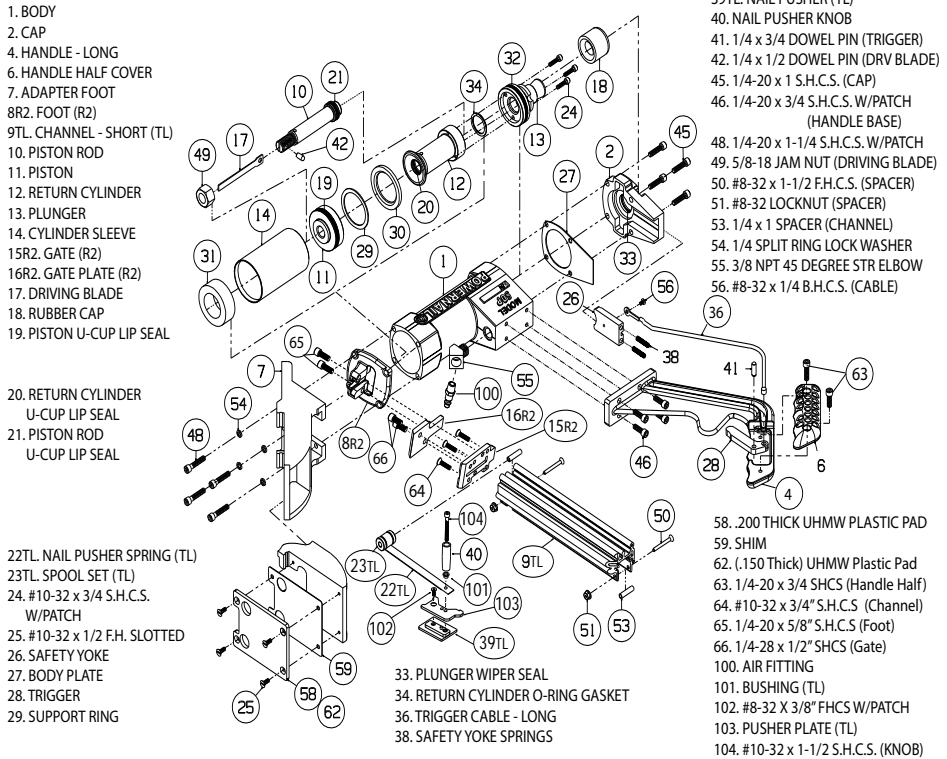

Kits Available - For use on all Model 50P, 50P FLEX, & 50P FLEX Power Rollers

*For Step-by-Step Videos and Instructions,
Visit our Web Site at: www.Powernail.com*

POWERCLEATS LENGTH DETERMINATION CHART

This chart will assist you in determining the proper length of Powercleats to use for various thicknesses of flooring. Approximate vertical penetration of the Powercleat under the hardwood floor is shown for each application. This is only a guide. Results should be tested in the field before proceeding.

Nail Penetration for 3/4" and 5/8" Underlayment

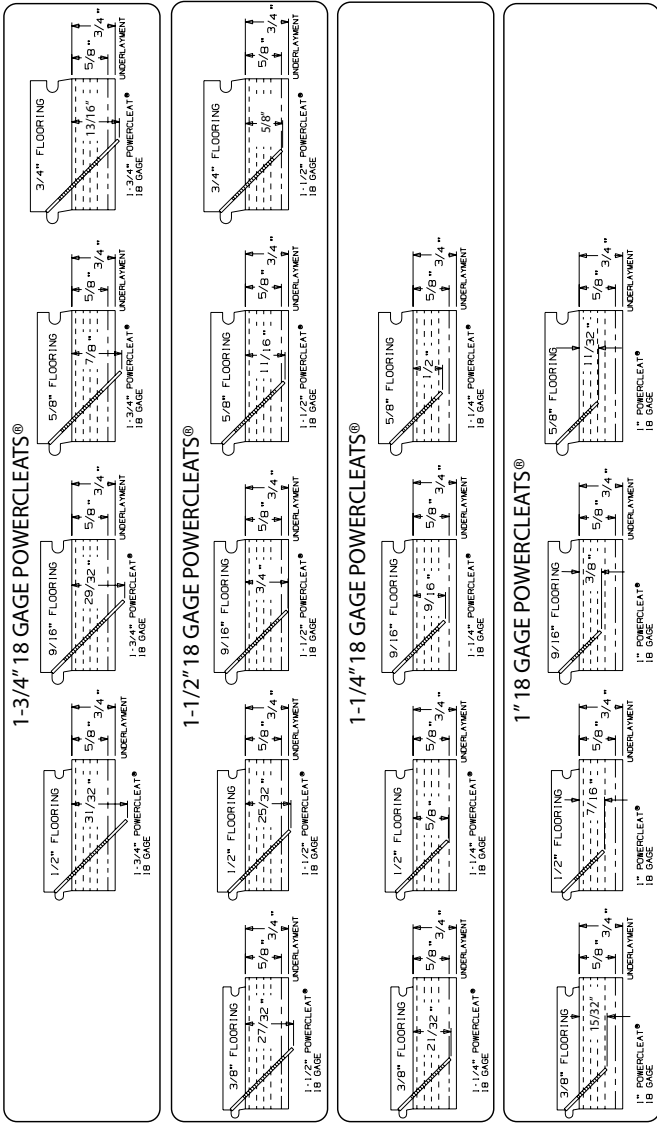

POWERNAILER TROUBLE SHOOTING CHART

	PROBLEM	POSSIBLE CAUSE	SOLUTION
1	Driving blade does not retract	1. Zero or Low air pressure	Check air supply for 80 psi minimum to 110 psi maximum
		2. Lack of lubrication	Manually lubricate through male air inlet fitting
2	Driving blade retracts slowly	3. Excessive dirt inside nailer	Disassemble and clean
		4. Bent or burred driving blade	Replace driving blade (#17)
		5. Seals worn out	Replace all seals (Seal Kit)
		6. U-Cup Lip Seals installed upside down	Replace all seals (Seal Kit)
		7. Low air pressure	Turn up air pressure to 80-110 psi max
3	Nail is not countersunk	2. Bent or burred driving blade	Replace driving blade (#17)
		3. Air supply restricted by small orifice	Use 1/4" minimum diameter air fittings
		4. U-Cup Lip Seals installed upside down	Replace all seals (Seal Kit)
		5. Excessive dirt inside nailer	Disassemble, clean and lubricate
4	Nailer leaks air	1. Low air pressure	Turn up air pressure to 80-110 psi max
		2. Broken Driving Blade	Replace Driving Blade (#17)
		3. Nail hit hard surface	Move from obstruction
		4. Piston U-Cup Lip Seal installed upside down	Replace all seals (Seal Kit)
		5. Driving blade jam nut came loose	Retighten or replace jam nut (#49)
		6. Worn out gate	Replace gate. (#15)
5	Bottom of nailer cracked off	1. Air supply fittings loose	Tighten all air line fitting connections
		2. Excess air pressure blew out seals	Check air supply for 110 psi maximum—replace all seals
		3. Plunger screws loose	Tighten 3 plunger screws (#24)
		4. Cracked or damaged body	Replace body (#1)
		5. Seals worn out	Replace all seals (Seal Kit)
		6. Seals need to be seated	Dry fire Nailer
6	Nails jam in nailer	1. Operated without rubber bumper installed	Replace damaged parts
		2. Excessive air pressure used	Replace damaged parts
		1. Not using 18 gage Powercleats nails	Use 18 gage Powercleats nails only
		2. Continued use after a short hit	Clear nail immediately after short hit
		3. Nail pusher damaged or spring broken	Replace nail pusher assembly (#A-9)
		4. Nail channel lose	Tighten nail channel retaining screws (#52,#48)
		5. Bent nail stuck in nail guide	Disassemble and clear out bent nail
6. Hit another set nail or hard object	Move from obstruction		
7	Plunger locked up—won't move or fire	7. Nail gate worn out	Replace nail gate (#15)
		1. Safety trigger not being depressed	Replace damaged plunger, safety yoke and plunger seal (#13,#26,#32)
		2. Lack of lubrication	Manually lubricate through male air inlet fitting

Clearing a jam with the new Revision 2 Foot.

1. Using a 3/16" hex wrench, remove the two gate plate screws.

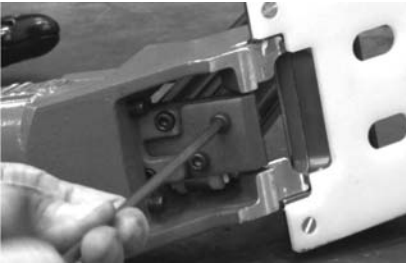

2. Slide and remove the gate plate.

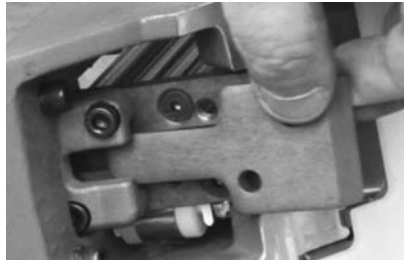

3. Inspect and clear any jams in the drive blade pathway.

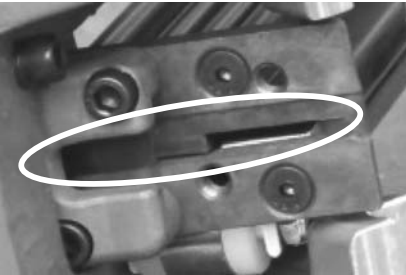

5. Re-install the gate plate and screws. Tighten firmly.

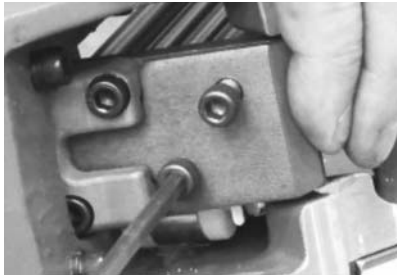

Nailer is now ready for use.

**Check out our Repair and Maintenance
Videos online at:
<http://www.powernail.com/repair>**